

**Baylands Raceway Park &
Budweiser King of Beers Presents**



BUD

SHOOT-OUT II

OCTOBER 10, 1987



This Bud's for You

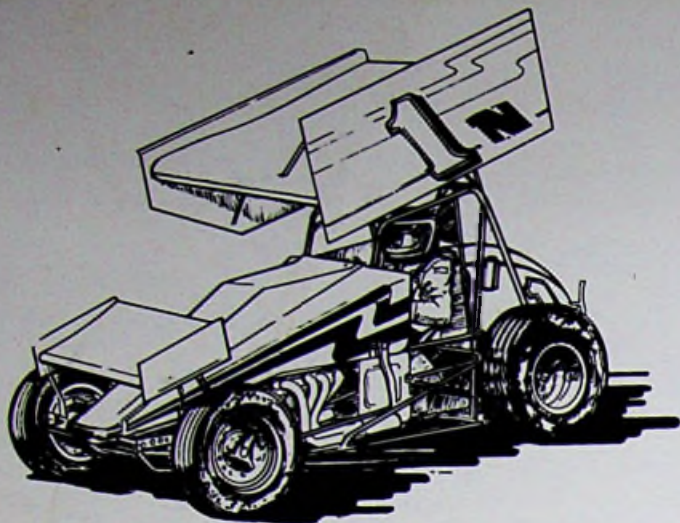

1987 NANCE SPRINT CARS / KITS

| | |
|--------------|-------------|
| Kit #1 | \$ 3046.50 |
| Kit #2 | \$ 4814.46 |
| Roller | \$11,636.94 |



(Call for full information sheet and special PRO RACER Packages)

RACING PARTS AND EQUIPMENT

If it is STATE OF THE ART . . . WE HAVE IT!
We are MANUFACTURER DIRECT with over 200 MANUFACTURERS!

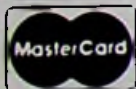

- * Nation-wide Parts Service . . . (We ship to race teams in every State of the nation . . . Special 'factory drop shipments' available to save you freight/time)
- * Over 26 Years of PROFESSIONAL racing experience
- * Dealer Inquiries Invited . . . We are NATIONAL WAREHOUSE DISTRIBUTORS for over 60 lines of HARD CORE RACE PARTS



408/292-8503

"THE RACERS GENERAL STORE"

**489 SOUTH MARKET ST.
SAN JOSE, CA 95113**

**SUNDAY - MONDAY: CLOSED
TUESDAY - FRIDAY: 10:00 - 7:00
SATURDAY: 9:00 - 5:00**

Baylands Raceway Park

President Terry Kniss
 Marketing Director David Vodden
 Announcer David Vodden
 Photographer Ed Bernhardt
 Track Preparation Jim Soares
 Maintenance Superintendent Ron Kniss
 Concessions Agnes Seale
 Concessions Geneva Hall
 Souvenir Sales Andy Brizzo
 Video Production Able Video
 Telephones (415) 651-2545
 Program Advertising, Production Chris Lopez
 Program Sales Amy and Tami Lopez
 Trophies Trophy City, San Jose
 Trophies Baylands Awards

Baylands Officials

Race Director Mike Read
 Chief Pit Stewart Jack McAfee
 Ass. Pit Stewart Lynette McAfee
 Referee Jake Flohr
 Asst. Referee Sound Vern Kornburst
 Pit Stewart Bruce Homer
 Asst. Stewart Ron Beaman
 Starter Willie Williams
 Scorer Patti Goddard
 Asst. Scorer Vickie Read
 Push Trucks Denny Hernandez
 Safety/Fire Nick Lowe
 Tow Service Cupertino Tow
 Tow Service \$15 Tow
 Ambulance Area Ambulance

The management of Baylands welcomes you and hopes that you enjoy yourselves at tonight's races. We regard our racing to be family entertainment, and encourage you to bring the entire family. While we do serve beer, along with other refreshments, we do not feel that its sale entitles anyone to behave in a manner that disturbs others who have paid to attend our events. We will under no circumstances tolerate drunkenness, rowdiness, foul language or fighting by anyone on these premises. If disturbance persists, we will not hesitate to have those responsible taken into custody and charged. Thank you for your attendance tonight, and please let us know if we can make your evening more enjoyable.

Special thanks to our billboard advertisers: Tri City Motors, Perdue Tire Co., KEEN Radio, Hilton Hotel - Newark, Seven-Up, G.M. Sports, Volkscraft, Check Center, Budweiser, Lightning Muffler, Reids Diesel Service, Frey Racing, Flow Master, Fremont Ford, Challenger Chassis, Russ Joseph Engines, Osteens Body Shop, Hour Portraits, Sunnyvale Welding, National Speed Center, Frontier Ford, Schoeber's Athletic Club, Racing Wheels, The Nuggett, Carls Jr. Restaurants, MADCO Welding, Golden Gate Upholstery, KNEW Radio.

We also want to thank our event sponsors for our sprint car shows: Reids Diesel Service, Red Lambeth Construction, National Cold Storage, Sunnyvale Welding, Lightning Muffler, Fremont Ford, Tri-C Machine, Lynch Pro-Formance Products, Rich Voss Trucking, Stevens Creek Quarry.

Photos courtesy of: Ed Bernhardt-Track Photographer; Eddie Carlson, Irene and Barry Gill, Sherrie Strong.

NATIONAL SPEED CENTER

PERFORMANCE EQUIP & AUTO PARTS



**ALL YOUR AUTOMOTIVE NEEDS
FOREIGN & DOMESTIC**

LOW WHOLESALE PRICES - LARGE INVENTORY

INCREASE GAS MILEAGE & POWER UP TO 50% WITH HEADERS
CARBS, MANIFOLDS, & IGNITION SYSTEMS

**AUTOMOTIVE MACHINE SHOP
BALANCING & BLUEPRINTING**



FLYWHEEL SURFACING
HIGH PERFORMANCE CLUTCHES FOREIGN & DOMESTIC

1950 W. SAN CARLOS ST. SAN JOSE 294-3400

MON THRU FRI 9 Til 6:00 SAT 9 Til 4:30 SUN 10 Til 4:00 **SINCE 1969**

No Caffeine
Never had it. Never will.



**ON
SALE
NOW
AT THE
CONCESSION STAND**

**7-UP NIGHT
WELCOMES YOU**



SEVEN-UP BOTTLING COMPANY
6805 SAN LEANDRO ST., OAKLAND, CALIFORNIA 94621

8x AL LEIST RACING 88

Al Leist
STOP SERVICE
LATE

BIG SAVINGS ON REPLACEMENT PARTS
GAMBLER — STANTON

Fits Most Sprinters & Modifieds

We Are The Direct Connection For:

J.B. CHASSIS ★ CARRILLO ★ HILBORNE

BRODIX HEADS ★ HOWARD CAMS ★ HOWARD RODS

RODECK BLOCKS ★ KINSLER ★ SPEEDWAY AIR FLOW WINGS

TILTON BRAKES ★ PARAGON STARTERS ★ SANDER ENGINEERING

ENGINE KITS ★ SPEED PRO ★ TRW ★ JET CRANKS

OUR ENGINES SURVIVE THE OUTLAWS

Remember . . . "Parts Is Parts"

1027 Howard Ave.
San Mateo, CA 94401

415-342-6196

**L & M POWER STEERING
AND TOOL COMPANY**
STANDARD & POWER STEERING GEARS
PUMPS AND ACCESSORIES

FOR:
FORD, LINCOLN- MERCURY
GENERAL MOTORS
AND CHRYSLER
ALSO TRUCKS

210 SAN JOSE AVE., BLDG. #10
SAN JOSE, CA. 95125

PHONE (408) 293-4766
(408) 293-1625

VOLKSCRAFT
VW Performance Center

Specializing in Air-Cooled V.W.'s

- ACCESSORIES
- SERVICE
- PARTS

Mon-Fri - 8:30-5:30
Sat 9 - 3



792-9974



5588-A CENTRAL AVE. NEWARK
(Corner Of Cedar)



The Perfect Shot™
of London
PHOTOGRAPHY

WEDDINGS- PORTRAITS
COMMERCIAL- INDUSTRIAL
& CAR RACING

(408) 280-1735
210 SAN JOSE AVE., BLDG #10
SAN JOSE, CA 95125

SAM TROPP
OWNER

PHOTOGRAPHY

WEDDINGS - PORTRAITS
COMMERCIAL - INDUSTRIAL
& CAR RACING

(408) 280-1735
210 SAN JOSE AVE., BLDG. #10
SAN JOSE, CA. 95125

THE HEAD MASTER

"QUALITY SERVICE = SATISFIED CUSTOMERS"

HEAD & ENGINE REMANUFACTURING



EXCHANGE SERVICE

REMANUFACTURED HEADS & ENGINES IN STOCK

AUTO
PARTS

SPEED
EQUIPMENT



FOREIGN - DOMESTIC - COMPETITION - CUSTOM

KITS
AVAILABLE

- ★ CAMSHAFT
- ★ CRANKSHAFT
- ★ ENGINE

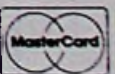

622-A CHARCOT AVE.
SAN JOSE 95131

[408] **435-1866**

Autographs

AL MEADOWS

Amador Valley Sign Co.

Custom Race Car Lettering

(415) 846-3839

39 California Ave. Suite 401 Pleasanton, CA

CHAMPION BEAD-LOCK

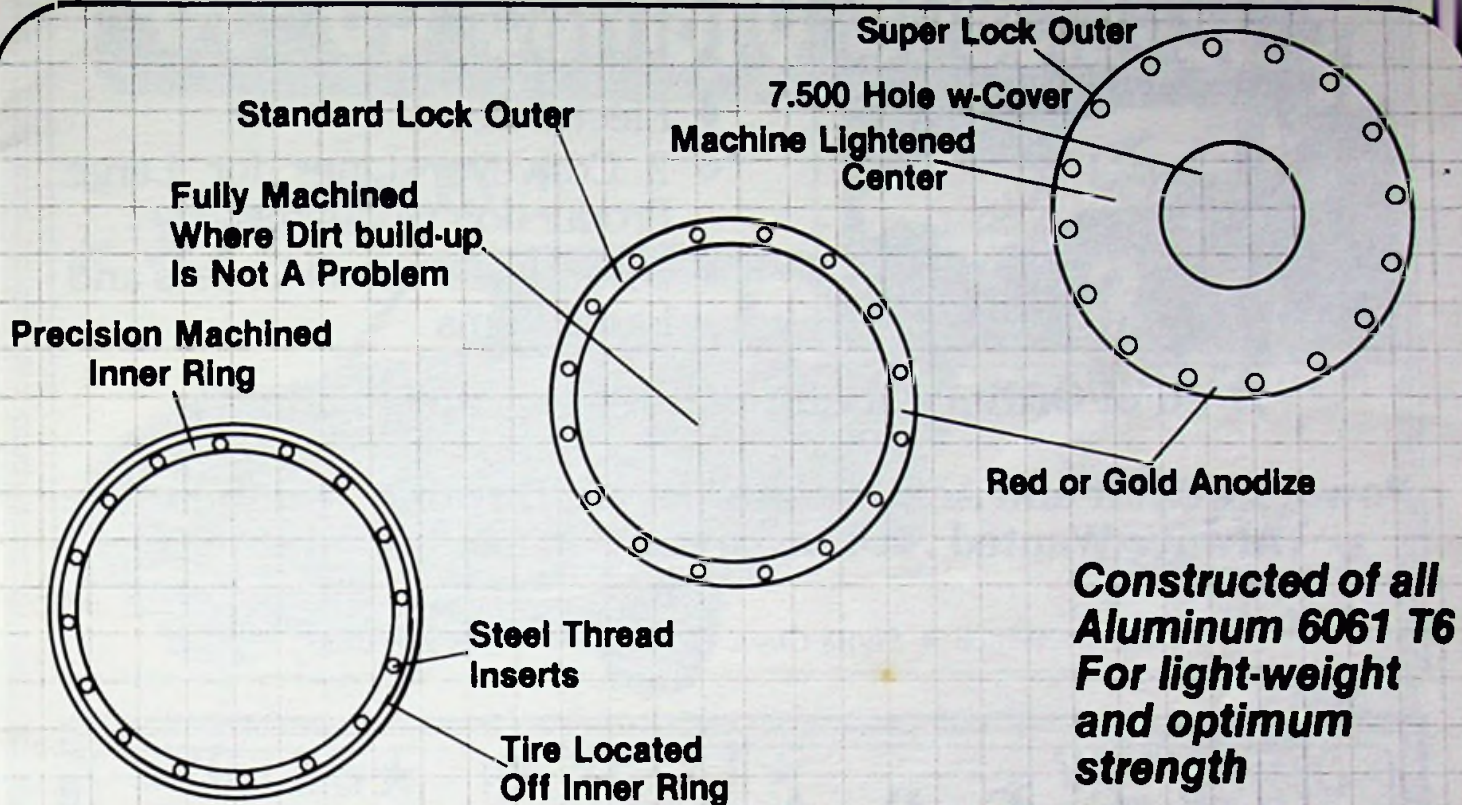

Constructed of all Aluminum 6061 T6 For light-weight and optimum strength

- AT LAST, A QUALITY BEAD LOCK YOU CAN INSTALL
- ALL PARTS ARE AVAILABLE SEPARATELY
- IN STOCK READY FOR IMMEDIATE SHIPMENT

For Today's Sophisticated

15"
SPRINT
STOCK
MODIFIED

13"
MIDGET
MINI STOCK
MODIFIED MIDGET

10"
MODIFIED MIDGET
QUAD RACER
ATV

**WE HAVE DEVELOPED THE TOUGHEST,
MOST DURABLE BEAD LOCK FOR YOU!**

SIMPLE TO ORDER

10"...\$ 74.95 13" - 15"....\$110.00with complete installation instructions

10"...\$ 84.95 13" - 15"....\$125.00.....installed on your wheel, fully machined and trued.

CALL OR WRITE TO:

3447 West University Fresno, CA 93711
(209) 275-5183



Add \$4.00 for Superlock
Same Day Service Shipped U.P.S.
Cal. Res. Add 6% Sales Tax

Component Finishing, Inc

We Specialize in Electrostatic Powder Painting

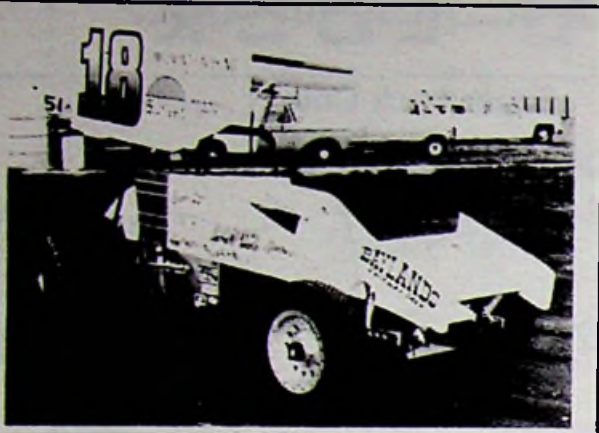

- Automotive
- Commercial
- Industrial
- Electronics
- 2 Conveyor Lines for Large Production Quantities
- 3 Booths for Small Orders and Large Items

Tired of Ordinary Paint Failing on Your Product?

Powder Coat it and Achieve the Tough, Durable Finish You've Always Wanted . . . But Thought Wasn't Available.

800 Aldo Avenue • Santa Clara, CA 95054 • (408) 988-6233

C C R A

Chris's Custom Racing Apparel

ULTRA CUSTOM DRIVING SUITS

for the Professional Racers

- Meets All Fire Standards
- Matching Pit Crew/Sponsor Clothing
- Repair and Alteration
- Certified for Nomex 1-4 Layers

Chris Day
(415) 490-8886

2000 Warm Spring Ct.
Fremont, #4, CA 94536



S/S ★ S/S-350 ★ S/S-396 ★ R/S ★ Z-28

'67-'69 Camaro Specialist!

★ UPHOLSTERY ★

★ CARPET SETS ★



★ EMBLEMS ★

★ PATCH PANELS ★

★ GRILLES ★

★ SHEET METAL ★

★ WEATHER STRIPPING ★

Your Complete '67 -'69 Camaro
Parts Store. Featuring
The World's Finest
In New And
Reproduced
Parts.

ROYAL CAMARO PARTS

3157 Alum
Rock Ave.
San Jose, CA 95127
(408) 258-2841
(408) 258-2842

★ ALSO FEATURING ★

- KONI SHOCKS
- TRW FRONT END PARTS
- CUSTOM SWAY BARS
- STOCK & POLYURETHANE BUSHINGS

BAYLINER *America's 1st Choice*

87' CLOSEOUT

VIP MARINE BRINGS YOU SNAG FREE FISHING !



1810 BASS STRIKER Bayliners top-of-the-line tournament bass boat ! Features electric trolling motor, digital depth indicator, CB radio and custom Escort trailer. With 125 hp Force outboard.

List \$ 10,595 **NOW ONLY \$ 9595**

87 CLOSEOUTS ~ READY TO GO !

13' COLUMBIAN 3000 Full value pkg. Boat, motor, & trailer
Built for long lasting strength and durability - List \$ 2,375
CLOSEOUT SALE PRICE \$ 1650

1400 CAPRI BOWRIDER Affordable sport runabout, ready for
skiing or all around fun. Boat, motor, & trlr. - List \$ 5,495
CLOSEOUT SALE PRICE \$ 4495

1900 CAPRI BOWRIDER Deluxe ski/sport runabout features
extra room and comfort. Boat, motor, & trlr. - List \$ 9,995
CLOSEOUT SALE PRICE \$ 8955

1950 CAPRI BOWRIDER Full value package - Boat, motor, & trlr
Designed after "Boat of the Year" winner - List \$11,695
CLOSEOUT SALE PRICE \$ 10,595

2150 CAPRI CUDDY Economical family cruiser with sleeping for
five and lockable forward cabin. 130 OMC I/O List \$ 19,595
CLOSEOUT SALE PRICE \$ 17,995

All prices plus prep, freight, tax, & opt.

Fuel, Service, & Dry Storage
Information at Oyster Point
415-952-3372 or
800-VIP-BOAT

VIP Marine

**POWER BOAT
MARINE FACILITY**

SAN JOSE
2955 So. Monterey Hwy.
(408) 225-5020

OAKLAND
351 Embarcadero
(415) 268-0201

REDWOOD CITY
East Side of Hwy. 101
(800) VIP-BOAT

SALINAS
801 El Camino Real North
(408) 443-0777

OYSTER POINT (South City)
Between East and West Basin
(415) 952-3372

300 + NEW BOATS NOW !

Now that you've finally decided to get off the pair and out on the water where you belong. VIP MARINE brings you a Snag Free Boat Buyers Program ~~~~~

FINANCING ~ Our computers will scan current lenders to get you the best possible rate and the lowest monthly payments
DELIVERY ~ Our gigantic inventory lets you have same day delivery on most boats

SERVICE ~ Our people are customer trained. They don't mind having to sweat a little to get you the best possible deal !
LOCATION ~ Five convenient bay area locations open seven days a week !

Monday - Saturday
9 am to 9 pm
Come out on Sunday
9 am to 7 pm



**DARRELL HANESTAD ANOTHER RETURNED "OUTLAW"
IN THE HANFORD TIRE ENTRY #8**



**JIMMY SILLS PASSES ED ORGAN
WITH HIS FRONT WHEELS IN THE AIR.**

ED BERNHARDT PHOTOS



RONNIE DAY #12 AND RANDY TURNER #2



**JEFF SWINDELL BEING REWARDED FOR HIS
FAST HEAT VICTORY AT BAYALNDS DURING
HIS LAST VISIT HERE**

Jerry Van Der Wal Photo



Rich Voss #35

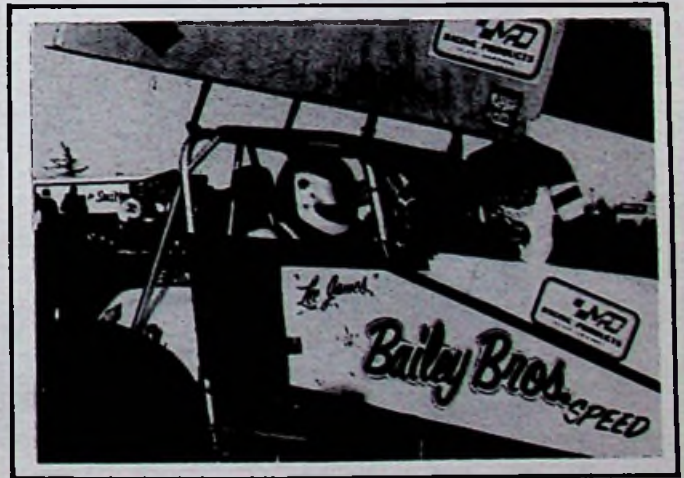

Lee James, Northridge, Ca. #1



**FIVE OF THE SIX MEN HOSTING THE GOLDEN STATE CHAMPIONSHIP SERIES.
DAVID VODDEN, BAYLANDS: DOUG FORT, SANTA MARIA: JOHN PADGENT,
SILVER DOLLAR SPEEDWAY: MIKE KINNEY, CALISTOGA AND JOHN SOARES, PETALUMA
Ed Bernhardt Photo**



DEAN NELSON, CAMPBELL AND ED ORGAN, NAPA

CALIFORNIA GOLDEN STATE SERIES

1987 POINTS

| | | |
|----|------------------|-----|
| 1 | STEVE KENT | 331 |
| 2 | BRENT KAEDING | 303 |
| 3 | TOMMIE ESTES JR. | 285 |
| 4 | RICH VOSS | 244 |
| 5 | MONTE FACCINTO | 238 |
| 6 | JIMMY SILLS | 217 |
| 7 | T.J. WINNINGHAM | 195 |
| 8 | JASON McMILLEN | 192 |
| 9 | GENE MANHIRE | 187 |
| 10 | CHUCK GURNEY | 178 |

1986 FINAL POINTS

| | | |
|----|------------------|-----|
| 1 | STEVE KENT | 109 |
| 2 | CHUCK MILLER | 84 |
| 3 | TOMMIE ESTES JR. | 79 |
| 4 | GARY LYNCH | 67 |
| 5 | T.J. WINNINGHAM | 63 |
| 6 | BRENT KAEDING | 60 |
| 7 | J.T. HAYES | 49 |
| 7 | RICK DOWNEY | 49 |
| 9 | LEE JAMES | 43 |
| 10 | GENE MANHIRE | 41 |

ALL TIME MAIN WINNERS

| | | |
|---|------------------|----|
| 1 | BRENT KAEDING | 5 |
| 2 | JIMMY SILLS | 3 |
| 3 | STEVE KENT | 2 |
| | TOMMIE ESTES JR. | 2 |
| 5 | RICK HIRST | 1 |
| | LEE JAMES | 1 |
| | JEFF SWINDELL | 1 |
| | | 15 |

| 1986 | Track | 1st Main | 2nd | 3rd | 4th | 5th |
|----------|-----------|------------------|------------------|------------------|------------------|------------------|
| April 26 | Baylands | Brent Kaeding | Tommie Estes Jr. | Wheeler Gresham | Wayne Bennett | Gary Lynch |
| May 25 | S. Maria | Brent Kaeding | Steve Kent | Tommie Estes Jr. | Chuck Miller | Gary Lynch |
| June 27 | Hanford | Steve Kent | Chuck Gurney | L. McSpadden | Gene Manhire | Gary Lynch |
| June 28 | S. Maria | Tommie Estes Jr. | Steve Kent | Gary Lynch | Chuck Miller | J.T. Hayes |
| Aug. 22 | Hanford | Brent Kaeding | Steve Kent | Chuck Miller | Ron Shuman | Craig Keel |
| Aug. 30 | Baylands | Lee James | Donnie Evans | Steve Kent | L. McSpadden | T.J. Winningham |
| 1987 | Track | 1st Main | 2nd | 3rd | 4th | 5th |
| April 11 | Baylands | Steve Kent | Chuck Miller | Dave Bradway Jr. | Tommie Estes Jr. | Pat Rose |
| April 25 | Petaluma | Rick Hirst | Chuck Miller | Brent Kaeding | Pete Shucklian | Lee James |
| May 29 | Hanford | Jimmy Sills | Jeff Swindell | Steve Kent | Tommie Estes Jr. | Bryan Bullard |
| May 30 | S. Maria | Jeff Swindell | Steve Kent | Lee James | Dave Bradway Jr. | Scott Luhdroff |
| June 26 | Chico | Brent Kaeding | Shane Scott | Terry Gray | Steve Kent | Monte Faccinto |
| June 27 | Chico | Brent Kaeding | Steve Kent | Dan Burton | Jimmy Sills | Terry Gary |
| July 17 | Hanford | Jimmy Sills | Steve Kent | L. McSpadden | Tommie Estes Jr. | D. Hanestad |
| Aug. 29 | S. Maria | Jimmy Sills | Steve Kent | Jeff Swindell | Ronnie Day | Gene Manhire |
| Sept. 6 | Calistoga | Tommie Estes | Darrell Hanestad | Brent Kaeding | Andy Hillenburg | Jac Haudenschild |
| Sept. 25 | Baylands | | | | | |
| Sept. 26 | Baylands | | | | | |
| 1986 | Track | FAST TIME | DASH | SEMI | | |
| April 26 | Baylands | Chuck Gurney | Wheler Gresham | Donnie Evans | | |
| May 25 | S. Maria | Tommie Estes Jr. | Don Case | Don Case | | |
| June 27 | Hanford | Chuck Miller | Gary Lynch | Pete Shucklian | | |
| June 28 | S. Maria | Steve Kent | J.T. Hayes | Rick Haugh | | |
| Aug. 22 | Hanford | Craig Keel | Steve Kent | Greg Rule | | |
| Aug. 30 | Baylands | Chuck Miller | Donnie Evans | Lee James | | |
| 1987 | Track | FAST TIME | DASH | SEMI | | |
| April 11 | Baylands | Chuck Gurney | Steve Kent | Rick Downey | | |
| April 25 | Petaluma | Chuck Miller | Steve Kent | Tommie Estes Jr. | | |
| May 29 | Hanford | Jimmy Sills | Steve Kent | Chuck Miller | | |
| May 30 | S. Maria | Jimmy Sills | Steve Kent | Tommie Estes Jr. | | |
| June 26 | Chico | Jason McMillen | Bryan Bullard | T.J. Winningham | | |
| June 27 | Chico | Terry Gray | Steve Kent | Marco Bowers | | |
| July 17 | Hanford | Tommie Estes Jr. | Steve Kent | Chuck Gurney | | |
| Aug. 29 | Calistoga | Jac Haudenschild | Jason McMillen | Lee Brewer | | |
| Sept. 25 | Baylands | | | | | |
| Sept. 26 | Baylands | | | | | |

1987 Bud Challenge Series

| DATE | DAY | EVENT | WINNER | SPONSOR | GATE | RACE |
|--------|-----|--|-------------------|------------------------------------|------|------|
| FEB 28 | SAT | WoO | Steve Kinser | | | |
| MAR 27 | FRI | Spring N | Lealand McSpadden | | | |
| MAR 28 | SAT | Spring N | Tim Green | | | |
| MAR 4 | SAT | Bud #1 | Jimmy Sills | Relds Diesel | | |
| 11 | SAT | Cal 1/Bud 2 | Steve Kent | Red Lambeth Const. | | |
| 18 | SAT | Bud #3 | Chuck Gurney | Nat. Cold Storage | | |
| 25 | SAT | Cal 2/Bud 4 | Rick Hirst | At Petaluma | | |
| MAY 2 | SAT | Bud #5 | Chuck Gurney | Sunnyvale Welding/Lighting Muffler | | |
| 16 | SAT | Bud #6 | Tommie Estes Jr. | Tera Nova Toys | | |
| 23 | SAT | Bud #7 | Jimmy Sills | | | |
| 25 | MON | Bud #8 | Brent Kaeding | | | |
| 29 | FRI | Cal 3/Bud9 | Jimmy Sills | At Hanford (Eddies) | | |
| 30 | SAT | Cal 4/Bud10 | Jeff Swindell | At Santa Maria | | |
| JUNE 5 | FRI | Summer N | Dave Bradway Jr. | | | |
| 6 | SAT | Summer N | Brent Kaeding | | | |
| 13 | SAT | Bud #11 | Jimmy Sills | Tri-C Machine | | |
| 26 | FRI | Cal 5/Bud12 | Brent Kaeding | At Chico | | |
| 27 | SAT | Cal 6/Bud13 | Brent Kaeding | At Chico | | |
| JULY 3 | FRI | Mid-Sum N | Chuck Gurney | | | |
| 4 | SAT | Mid-Sum N | Ronnie Day | | | |
| 11 | SAT | Bud #14 | Ronnie Day | | | |
| 17 | FRI | Cal7/Bud15 | Jimmy Sills | At Hanford (M&L Plumbing) | | |
| 18 | SAT | Bud #16 | Jimmy Sills | Don Chapln Const. | | |
| 25 | SAT | Bud #17 | Jimmy Sills | | | |
| AUG 1 | SAT | CRA RACE | Scott Luhdorff | | | |
| 8 | SAT | Bud #18 | Brent Kaeding | Tera Nova Toys | | |
| 15 | SAT | Bud #19 | Steve Kent | | | |
| 22 | SAT | Bud #20 | Darrell Hanestad | Armour Hotdogs | | |
| 29 | SAT | Cal8/Bud21 | Jimmy Sills | At Santa Maria | | |
| SEPT 3 | THU | WoO | Steve Kinser | | | |
| 4 | FRI | WoO | Darrell Hanestad | | | |
| 5 | SAT | WoO | Steve Kinser | | | |
| 6 | SUN | Cal9/Bud22 | Tommie Estes Jr. | At Calistoga | | |
| 7 | MON | Bud #23 | Bobby Davis Jr. | | | |
| 25 | FRI | Calif. Golden State #10 / Bud #24 | | | 5PM | 8:00 |
| 26 | SAT | Calif. Golden State Final / Bud #25 | | | 5PM | 7:30 |
| OCT 3 | SAT | Bud Challenge Series #26 | | | 5PM | 7:30 |
| 10 | SAT | Bud Challenge Series Final / Bud Shoot Out | | | 5PM | 7:30 |
| 24 | SAT | Calvalcade of Auto Racing | | | 3PM | 7:00 |
| NOV 6 | FRI | Winter Nationals - G.P. Classic | | | 5PM | 8:00 |
| 7 | SAT | Winter Nationals - G.P. Classic | | | 5PM | 7:30 |
| 14 | SAT | Last Sprint Car Race Open Comp. | | | 5PM | 7:30 |

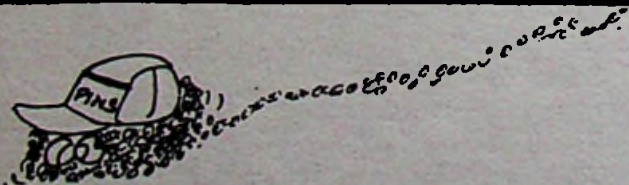

TIM MALONEY

UNIQUE PINS and RACING DECALS

STOCKTON, CA 209 / 239-9069

Bob's Dream World

Authentic Model Sprinters
Midgets & Modifieds

ROBERT OLSON
21240 Garden Ave.
Hayward, CA 94541

(415) 785-2454
Special Orders
By Request

SPORTS

RACING GASOLINE TM

SPORTS RACING GASOLINE was designed for **all** your critical high performance needs. **SPORTS CARS, STOCK CARS, DRAG CARS, MOTORCYCLES, BOATS, OFF ROAD RACERS and MORE!!**



"10-15% MORE H.P." Louie Unser

115 octane

4.2 gms lead/gal

.72 specific gravity

IBP 95°

EP 27°

Runs **COOL**

(up to 100° less exhaust temp.)

CALL: BAY AREA (408) 723-FUEL

L.A. AREA (213) 437-4373

DEALER INQUIRIES INVITED!

Park Performance

75 Minnis Circle, Milpitas
(408) 263-2067

B & B Competition Engineering

200 Linden St., Santa Cruz
(800) 223-4142 / (408) 423-6161

Sheen Distributing

1161 Terren St., Salinas
(408) 422-8062

Cleland Distributing

1021 Beamer St., Woodland
(916) 662-4207

BAPCO/Holdener Petroleum Co.

Stockton & Hedding Sts., San Jose
(408) 294-4513

Elgins-Techcraft

55 Perry St., Redwood City
(415) 364-0953

Supercuts Racing

1309 Ross St., Petaluma
(707) 778-0500

Les' Texaco

213 Corral DeTierra, Salina
(408) 484-2234

Rodrigues Racing Equipment

2970 Daylight Way, San Jose
(408) 227-6262

Klug's Marine Performance

1804 Santa Fe Road, Tahoe Paradise
(916) 577-3303

BAPCO/Holdener Petroleum Co.

1565 Industrial Pkwy. West, Hayward
(415) 783-6500

SPORTS
RACING GASOLINE

SPORTS
RACING GASOLINE

SPORTS
RACING GASOLINE

SPORTS
RACING GASOLINE

SPORTS
RACING GASOLINE

| <u>QUALIFY</u> | <u>TIMES</u> | <u>CAR#</u> | <u>DRIVER</u> | <u>TOWN</u> | <u>OWNER</u> |
|----------------|--------------|-------------|-------------------|-----------------|------------------|
| | | 1 | Sammy Swindell | Bartlett, TN | Raymond Beadle |
| | | 1B | Rick Bussell | Saratoga | Ray Bussell |
| | | 1C | Jason McMillen | Carmichael | Jack Gordon |
| | | 1st | Lee Brewer Jr. | | Daryl Saucier |
| | | 1T | Jeff Swindell | Memphis, TN | Trigueiro Bros. |
| | | 1X | Gene Manhire | Fresno | Mike Hasebe |
| | | 2 | Jac Haudenschild | Millersburg, OH | Ted Lee |
| | | 2 | Randi Turner | San Jose | Randi Turner |
| | | 2P | Scott Luhdroff | San Jose | Dave Castro |
| | | 2R | Brian Gray | Hayward | Brian Gray |
| | | 2T | Ted Lee | El Paso, TX | Ted Lee |
| | | 2X | Monte Faccinto | Fresno | Tony Dias |
| | | 2XS | Craig Dykkeston | Pittsburg | Craig Dykkeston |
| | | 3C | Tommie Estes Jr. | Ada, OK | Tri-C Machine |
| | | 3DB | Chuch Gurney | Livermore | Ed Ulyate |
| | | 3N | Ted Montague III | Fremont | Ted Montague Jr. |
| | | 3W | Cliff House | San Jose | Cliff House |
| | | 4 | | | Don Snow |
| | | 4P | Kenny Castro | San Jose | Dave Castro |
| | | 5 | Steve Kent | Fresno | Dannell De Hart |
| | | 5C | Jamie Cavagnaro | Mt. View | Jim Cavagnaro |
| | | 5X | Greg Rule | Rodeo | Greg Rule |
| | | 6 | Bobby Davis | Memphis, TN | Paul Morgan |
| | | 6 | Danny Smith | Danville, IN | Jim Reid |
| | | 7 | Terry Gray | Memphis, TN | Don Berry Const |
| | | 7G | Gary Lynch | Atascadero | Gary Lynch |
| | | 7R | Ron Shuman | Tempe, AZ | Gary Runion |
| | | 7X | Pat Seeley | Fremont | Pat Seeley |
| | | 8 | Darrell Hanestad | San Leandro | Brock Robertson |
| | | 9 | Keith Nafzger | San Jose | Joe Brown |
| | | 9A | T.J. Winningham | Monte Vista | T.J. Winningham |
| | | 9N | Kelly Newman | Sunnyvale | Don Von Schritlz |
| | | 10 | Lealand McSpadden | Tempe, AZ | Casey Luna |
| | | 11 | Steve Kinser | Bloomington, IN | Karl Kinser |
| | | 11X | Brent Kaeding | Campbell | Williams Bros. |
| | | 12 | Ronnie Day | Salinas | Don Chapin |
| | | 14 | Jimmy Sills | Placerville | Owen/Smith |
| | | 14B | Marco Bowers | Pleasanton | Dan Bowers |
| | | 14N | Tres Gurney | Danville | Bob Fulp |
| | | 16 | Tate Edwards | Watsonville | Tate Edwards |
| | | 16T | Tony Lutar | Canada | Jack Leatherman |
| | | 16X | Kyle Schild | Sacramento | Neil Schild |
| | | 17B | Bobby Buhler | San Jose | Leonard Alama |
| | | 17E | Cris Eash | | E & G Classics |

| <u>QUALIFY</u> | <u>TIMES</u> | <u>CAR#</u> | <u>DRIVER</u> | <u>TOWN</u> | <u>OWNER</u> |
|----------------|--------------|-------------|------------------|--------------------|-----------------|
| | | 18 | Brad Doty | Fredericksburg, OH | Marks/Kepler |
| | | 18L | Dave Lopez | Union City | Dave Lopez |
| | | 18N | Rick Hirst | Sacramento | DuWayne Starr |
| | | 20 | Rocky Hodges | | Edward Chinen |
| | | 20J | Dale Johnston | Newark | Don Johnston |
| | | 21 | Lee James | Northridge | Paul Torzilli |
| | | 21C | Bobby Michnowicz | Carson | Bob Michnowicz |
| | | 21W | Steve Beitler | Sedro Woolley, WA | Steve Beitler |
| | | 23 | Greg Wooley | Oklahoma City, OK | Greg Wooley |
| | | 25K | George Koerber | Campbell | George Koerber |
| | | 26 | Charlie Correia | Tracy | Charlie Correia |
| | | 27 | Allen MacLean | Saratoga | Kathy MacLean |
| | | 30J | Greg Kaila | Sunnyvale | Ed Kaila |
| | | 33 | Joe Donahoo | San Jose | Joe Donahoo |
| | | 34 | Dean Nelson | Campbell | Dean Nelson |
| | | 35 | Rich Voss | Cupertino | Rich Voss |
| | | 39 | | | Jim Klein |
| | | 40 | Lindsey Casto | Los Altos | Harold Casto |
| | | 41 | Tony Rozendahl | Clayton | Tony Rozendahl |
| | | 45X | Johnny Herrera | Albuquerque, N.M. | Joe Herrera |
| | | 47 | Shane Scott | Chico | Mike Kitchell |
| | | 47X | Larry Tachousky | Stockton | Larry Tachousky |
| | | 48 | Dave Blaney | | Nott Honda |
| | | 49 | Cecil Walker | Enumclaw, WA | Cecil Walker |
| | | 51 | Mark Kinser | Oolitec, IN | Karl Kinser |
| | | 57 | John Golobic | Sunnyvale | Rich Ayer |
| | | 57N | Brad Beaughan | San Leandro | Jim McCarthy |
| | | 65 | Ricky Williams | Castro Valley | Bill Williams |
| | | 67 | John Robinson | San Jose | John Robinson |
| | | 71 | Mike McCreary | Placerville | Mike McCreary |
| | | 71X | Rick Haugh | San Jose | Lovell Bros. |
| | | 72 | Jim Eiland | Taft | Jim Eiland |
| | | 76 | Marv Webster | Mill Valley | Marv Webster |
| | | 77 | Pete Shucklian | Visalia | Harold Haynes |
| | | 78X | Pat Rose | San Jose | Fred Lopez |
| | | 80 | Rick Downey | Santa Cruz | Jim Aduddell |
| | | 86 | Don Meyer | Calistoga | Don Meyer |
| | | 88 | Tim Gee | Whitehorse, CAN | Gordon Gee |
| | | 88L | J.T. Hayes | Memphis, TN | Al Leist |
| | | 98 | Dave Masters | Napa | Dave Masters |
| | | 98X | Mike John | Santa Clara | Mike John |
| | | | | | |
| | | | | | |
| | | | | | |
| | | | | | |

INTRODUCING THE ULTIMATE AUTOMOTIVE POLISH/FINISH

Liquid Glass



CONNOISSEUR'S CHOICE®
LEATHER, VINYL and
UPHOLSTERY PROTECTANT



*run with
a WINNER...*



LIQUID GLASS REMOVES scratches, tar, bugs, berry stains, oxidation, water spots, sap, overspray, slideswipe, timerot, road salt permeation, hazing on decals, hi-lo spots, graffiti, grease, oil and gas stains, rust on chrome, tanish on aluminum, gold, brass, etc., scratches and yellowing in plexiglas and plastic, etc.

ONCE APPLIED LIQUID GLASS IS gasoline retardant, scratch, salt water, and salt air resistant, heat and burn retardant

NOTHING BEATS "GLASS" ON FIBERGLAS OR METAL. IN FACT, 5 COATS OF LIQUID GLASS IS THE EQUIVALENT OF 1 COAT OF CLEAR LACQUER, YET IT IS 50 TIMES HARDER.

| | | | | | | |
|---|---|---|--|---|---|---|
| CUPERTINO CORVETTE STOP 20122 Stevens Creek | HAYWARD CALIF. MARINE CENTER 25125 Mission Blvd. | NAPA TRANS EUROPEAN MOTORS 800 Vallejo St. | RANCHO CORDOVA CHEVYLAND 11251 Coloma Rd. | SACRAMENTO Z-CAR SPECIALTIES 108 Otto Circle | SAN MATEO RICK'S EXECUTIVE AUTO DETAIL 342 Sonora Dr. | SANTA CLARA CORVETTE CLINIC 60 N. Winchester Blvd. |
| DAVIS PARTS UNLIMITED 920 3rd St. | TENNYSON HARDWARD 1120 W. Tennyson Rd. | OAKLAND KING'S AUTO ELECTRIC 2550 High St. | RICHMOND WILD BILL'S TRUCK ACCESSORIES 1181 23rd St. | SAN MATEO D & R AUTO BODY 1317 So. Railroad Ave. | SAN RAMON LINDY'S AUTO REB. 38 Beta Cl. A-3 | SANTA ROSA COUNTACH AUTO DETAIL 705 Sanat Rosa Ave. |
| DUBLIN BURNS EUROPEAN MOTORS 6787 Dublin Blvd. | TRUCK STORE 25714 Mission Blvd. | LIVERMORE TRI-VALLEY AUTO BODY 3561 1st St. | <p>\$2.00 Save two dollars when you buy 1 can of Liquid Glass and 1 bottle of Connoisseur's Choice. (Or save two dollars when you buy 2 cans of Liquid Glass)</p> <p>BONUS BUCK\$</p> <p>\$2.00 Coupon valid only at stores listed above or with Cal. Classic Finishes. This coupon may not be used in conjunction with any other coupon.</p> <p>\$2.00</p> <p>No cash redemption valve. Expires 12-31-87 California Classic Finishes P.O. Box 3593, Napa, Ca. 94558 (707)252-4200</p> | | | VACAVILLE TRANS EUROPEAN MOTORS 1011 Mason St. |
| EL SOBRANTE DAM CYCLE 4036 San Pablo Dam Rd. | LOS GATOS MAJN AUTO PARTS 291 E. Main St. | MODESTO MODESTO CUSTOM ACCESSORIES 1249 McHenry | | | | VALLEJO BILL'S TIRE & WHEEL 616 Tuolumne St. |
| FAIRFIELD TRANS EUROPEAN MOTORS 2020 N. Texas St. | MODesto MODESTO CUSTOM ACCESSORIES 1249 McHenry | NAPA BOB'S TEXACO 2442 W. Imola Ave. | TRANS EUROPEAN MOTORS 310 Tennessee St. | | | |
| FREMONT FINISH LINE 37394 Fremont Blvd. | | | | | | |

_____ 1 Pint Can Liquid Glass \$17.95
 _____ 1 8oz. bottle Connoisseur's Choice \$7.95
 _____ 1 Case (12 Pints) \$170.00
 _____ Professional Polish Application Cloths 3/\$5.00
 _____ Professional Buffing Cloths 3/\$7.00

All prices include UPS charges.
 Calif. residents add 6% State Sales Tax

Send check or money order to:
 California Classic Finishes
 P.O. Box 3593
 Napa, Ca. 94558
 (707) 252-4200

Name _____
 Address _____
 City, State, Zip _____
 Tel. # _____

DEALER INQUIRIES CALL DIRECT (707) 252-4200

METCALF RACEWAY PARK

HOME OF THE SOUTH COUNTY MICRO MIDGETS

& MINI SPRINTS



MICRO
MIDGETS

Exciting Dirt Racing
1/8 mi. banked oval
Sat. evenings April thru October
great racing • food & fun for
everyone

MINI
SPRINTS

For information call:

Danny Freitas
Days: (408) 243-0432 or Evenings: (408) 248-0509

or

Tim De Carlo
Days: (408) 842-8124 or Evenings (408) 779-9998

Located in San Jose:

Take 101 South to Bernal exit, turn left on Monterey Rd., go south 1 mi. to Metcalf Rd., turn left, go 2 mi. uphill to race track.

Gates open 5:00 pm
practice 6:00 pm
qualify 7:00 pm
racing 8:00 pm

ANDY'S tee-shirts ANDY'S tee-shirts ANDY'S tee-shirts ANDY'S tee-shirts

ANDY'S tee-shirts ANDY'S tee-shirts ANDY'S tee-shirts ANDY'S tee-shirts



ANDY'S tee-shirts

ANDY'S tee-shirts ANDY'S tee-shirts ANDY'S tee-shirts ANDY'S

Specialists in custom printed
tee-shirts, jackets, hats
& sports apparel

CUSTOM ORDERS AVAILABLE FOR YOUR
RACE TEAM, CLUB, ORGANIZATION OR EVENT

Full service art department to turn your ideas into reality.

CALL SUE FOR QUOTES

1091 SHARY CIRCLE
CONCORD, CA 94518

415 825-8911

ANDY'S tee-shirts ANDY'S tee-shirts ANDY'S tee-shirts ANDY'S tee-shirts

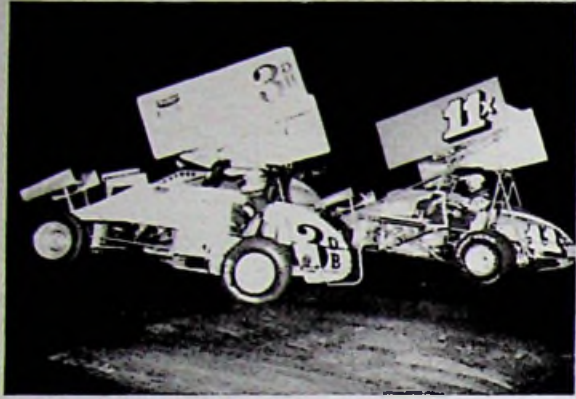

Chuck Gurney #3DB and Brent Kaeding #11X two California hopefuls to take home the "BIG \$"
Photo By Ed Bernhardt



Steve Kent of Fresno current point leader at Baylands
Photo By Ed Bernhardt



Jimmy Sills hoping to put #14 in Winners Circle again
Photo By Ed Bernhardt



JOHN ROBINSON OF SAN JOSE

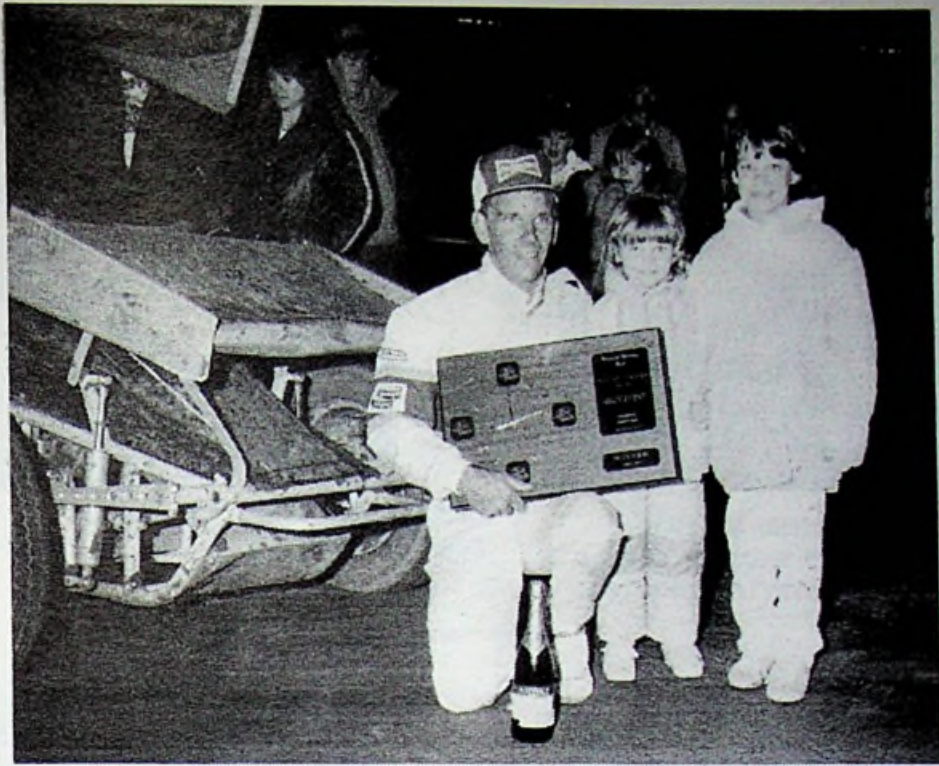

JIMMY SILLS IN VICTORY CIRCLE WITH TWO YOUNG FANS ON OPENING NIGHT OF THE BUDWEISER CHALLENGE SERIES AT BAYLANDS ON APRIL 4TH.



MIKE MCCREARY, PLACERVILLE: ED ORGAN, NAPA: AND SHANE SCOTT, CHICO



JIMMY SILLS ANOTHER DRIVER TO PUT THE ALL-WELD ENTRY INTO VICTORY CIRCLE AFTER HIS RETURN FROM THE OUTLAW TOUR



CHUCK GURNEY AND THE FAMILY IN VICTORY CIRCLE EVEN THE NEW BABY GETS IN THE PICTURE



DAVE LOPEZ #18 AND JOHN GOLIBIC #57



DARRELL HANESTAD AND THE TERRA NOVA PEEK-A-BOO BEAR

ED BERNHARDT PHOTOS



TOMMIE ESTES IN HIS FIRST TRIP TO VICTORY CIRCLE AT BAYLANDS RACEWAY IN THE #14 ALL-WELD ENTRY

High Performance

OF SAN JOSE INC.

926-8830

31 S. CAPITOL AVE., San Jose
(Alum Rock & Capitol)

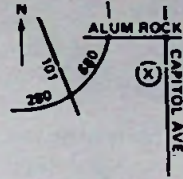

**VOLKSWAGEN & JAPANESE
PARTS — ACCESSORIES — REPAIRS**

COMPLETE REPAIR SERVICE

NISSAN

HONDA

TOYOTA

VW'S

COMPLETE ENGINE & TRANSMISSION REBUILDING

COMPLETE REPAIR SERVICE

REPLACEMENT PARTS

PARTS & SERVICE

MON-FRI 8 AM - 6 PM

PARTS ONLY

SAT 9 AM - 5 PM

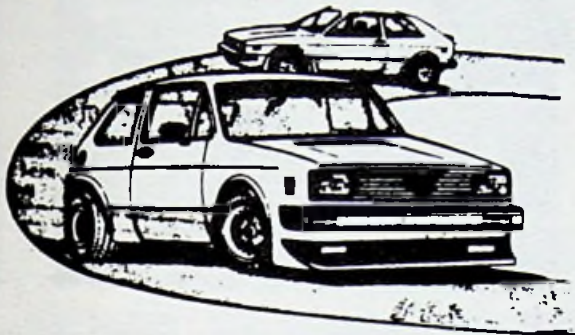

324 MOWRY AVENUE
FREMONT, CA 94538

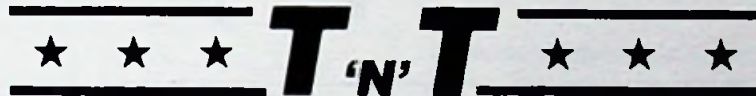

415 / 793-7576

MUFFLERS AND AUTO REPAIR



EXHAUST SYSTEMS FOR MOTOR HOMES AND ALL CARS

DOMESTIC & FOREIGN
BRAKES ● TUNE-UPS ● AIR CONDITIONING

COMPLETE REPAIR SERVICES





"CALL

GEORGE KUNZ



TODAY"

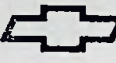

THE *Heartbeat* OF AMERICA  TODAY'S CHEVROLET

ED CORDERO

CHEVROLET
555 Oceana Blvd
Pacifica, CA 94044

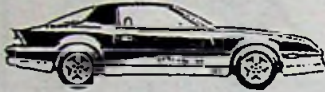

415-355-3433

in san francisco 415-993-5373



Denny's

BODY & PAINT
(415) 790-1361

37473 GLENMOOR DR.
FREMONT, CA. 94536



THUNDERBIRD
INN

WELCOMES
BAYLANDS RACERS
FOR RESERVATIONS
CALL 415-792-4300

39⁹⁵ + TAX
PER ROOM
Single or double occupancy.
Children stay free.

- ◆ Plenty of Parking - Excellent for All Types of Vehicles
- ◆ Security Service
- ◆ Located 2 miles from Baylands Raceway
- ◆ Pool, Sauna, Jacuzzi
- ◆ Full Service Restaurant & Cocktail Lounge
- ◆ Mention You're with Baylands to Receive Rate

5400 MOWRY AVE. ◆ FREMONT, CA 94538

**MIDGETS • SPRINTS
MODIFIED**



- PHOENIX FIRE SYSTEMS
- RJS SAFETY BELTS
- FUEL INJECTIONS
- GRADE 8 BOLTS-NUTS
- DZUS FASTENERS
- HALIBRAND & JONES REAR ENDS
- RACING WHEELS
- SCHRODER STEERING
- FUEL BLADDERS

WORTH RACING UNIFORMS • METHANOL
JFZ BRAKES • VERTEX MAGNETOS
FORD V8-60 ENGINE PARTS
• CHROMOLY TUBING • ALUMINUM SHEETS
CARRERA RACING SHOCKS
HOOSIER-FIRESTONE-McCREARY RACING TIRES

**NORM RAPP RACING
EQUIPMENT**

5 CORDOVA ST. (Near Geneva and Naples)
SAN FRANCISCO 94112 (415) 333-8510

JMSCO AUTOMOTIVE

Antique • Classic • Custom • Performance
Complete Automotive Services

JAMES M. SNYDER

1452 S Main St "D"
Milpitas, CA 95035

Telephone
(408) 263-3715

SERVING THE GREATER BAY AREA

KB

PAINTING, INC.
COMMERCIAL RESIDENTIAL

INTERIOR EXTERIOR

LIC # 416626

(415) 483-1316
SAN LEANDRO

HANK, SHARON AND KARI BUTCHER



DENNIS GUERRA
1273 PEDRO ST. #6
SAN JOSE, CALIF. 95126

(408) 287-1982

"Handcarved &
Painted Souvenirs"

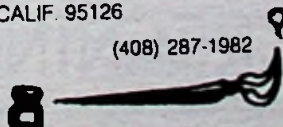

SPECIALIZING IN CUSTOM
PRINTED JACKETS, TEE-
SHIRTS, HATS AND
SPORTS ATTIRE.

Ron Walters

ATHLETIC SPORTSWEAR and IMPRINTS

* 5409 CENTRAL AVE. • #6 • NEWARK

CALL _____

(415) 792-6170

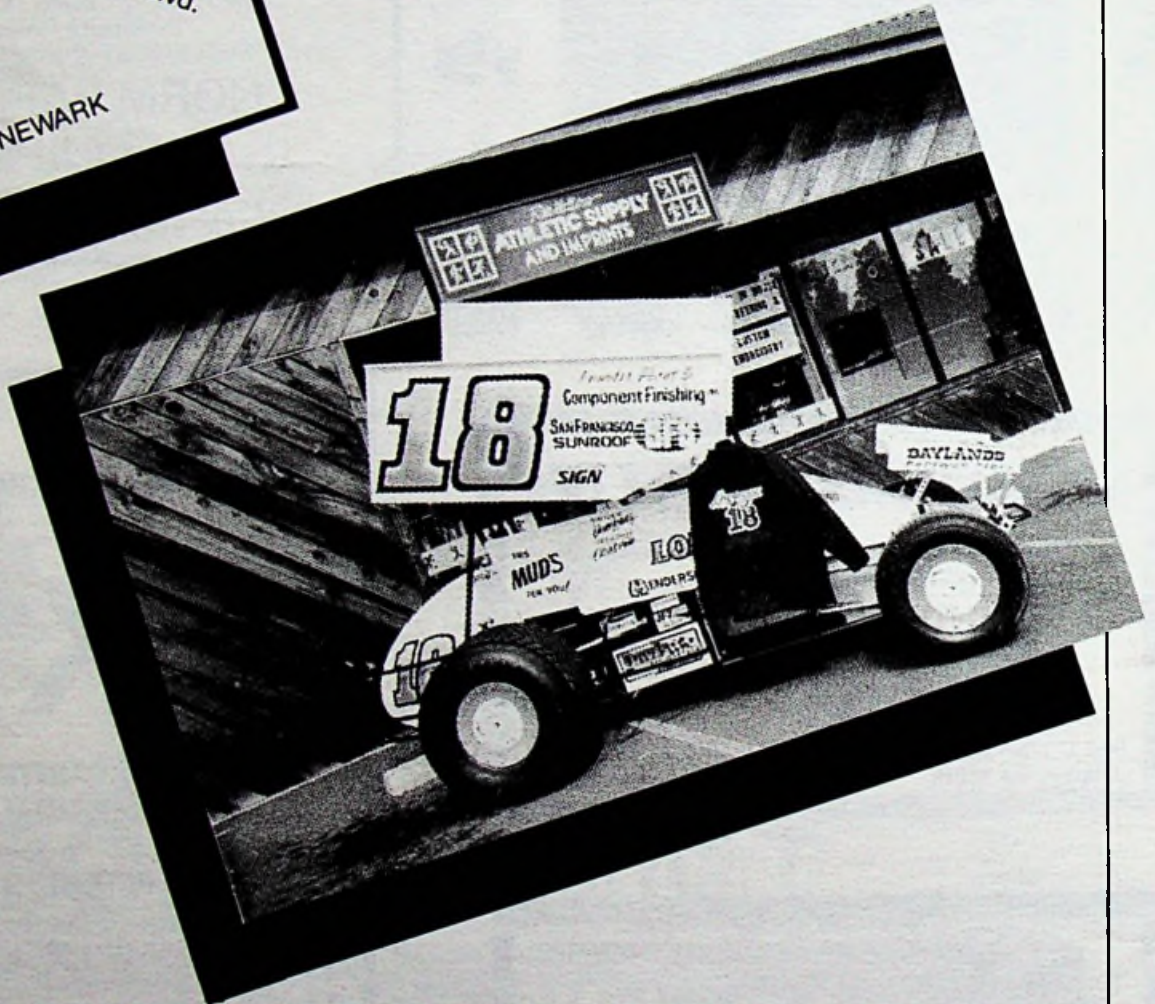
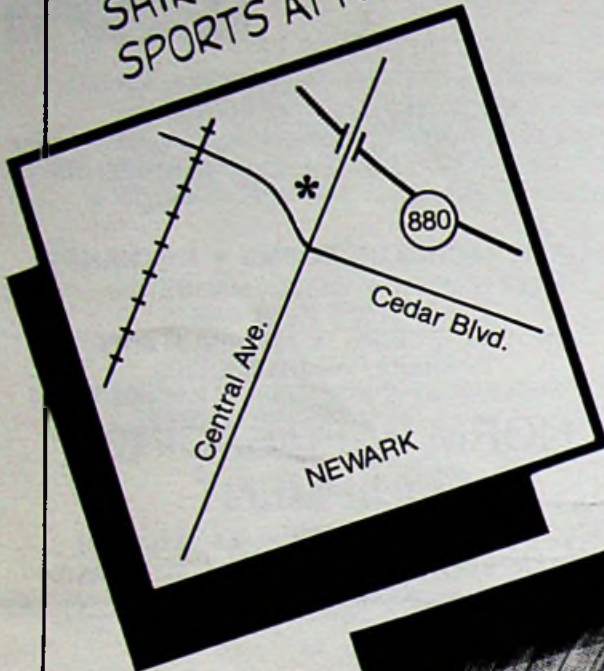

- CUSTOM EMBROIDERY
- CUSTOM SILKSCREENING

RTO RENTS

RTO the Original RENT-TO-OWN is proud to sponsor "Flying" Pete Shuklian and the RTO Special #77 Watch Flying Pete Shuklian become #1 and for VCR'S, Stereo's, furniture and Appliances be sure to visit the RTO store nearest you.

RTO INC / HAYNES-SHUKLIAN RACING

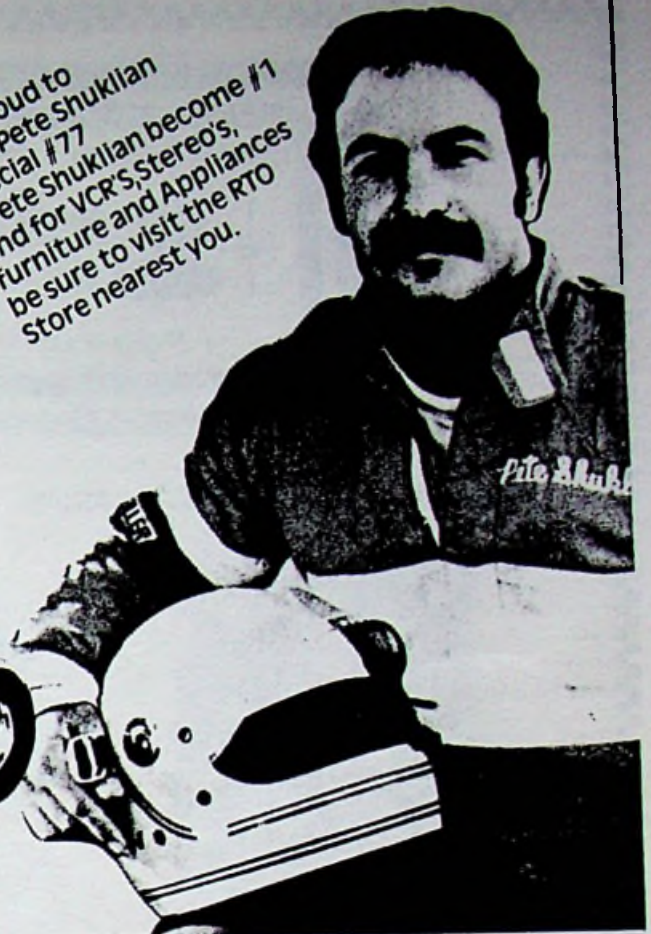
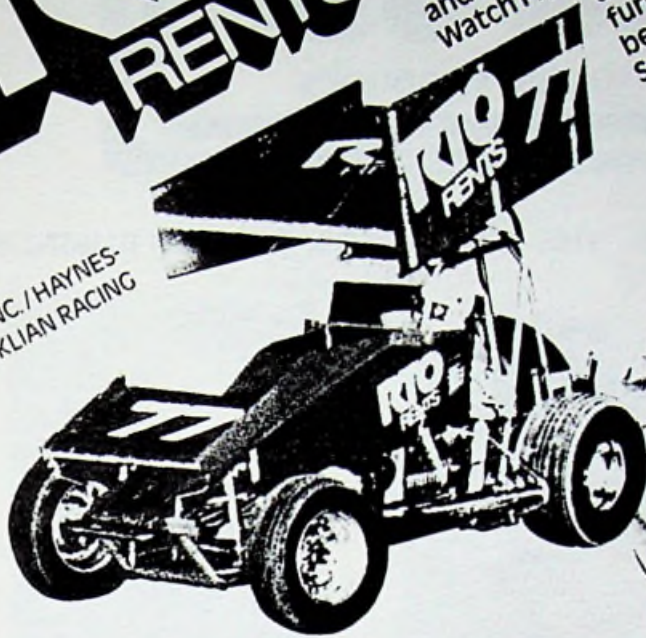

SAVE UP TO 100%

IT'S FREE!

Free Classified Ads...
as many as you like...
as long as you like...

FREE!

CALL BAY CLASSIFIED

415-538-3100

408-496-6444

415-584-9100

707-648-FREE

BAILEY BROS.

PERFORMANCE AUTO PARTS

- SPECIALIZING IN QUALITY ENGINE KITS
- Complete Line of Circle Track Equipment
- Complete Inventory of engine Parts
- VALLEJO ONLY
- Most Complete High Performance Machine Shop on the West Coast
- Engine DYNO Service

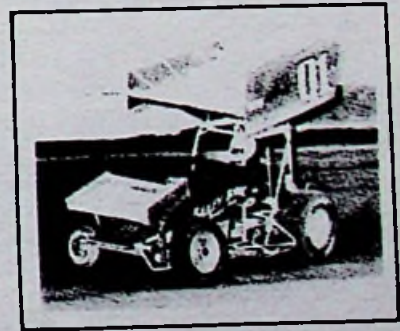

VALLEJO

NAPA

SACRAMENTO

642-7744

255-6020

922-5822

4901 NAPA-VALLEJO HWY (HWY 29)
(GREEN ISLAND RD. EXIT)
VALLEJO, CALIF. 94589

1500 C EL CAMINO
(2 BLOCKS WEST
OF 180)

INNOVATION INTEGRITY EXCELLENCE

LYNCH

PRO-FORMANCE PRODUCTS

WE HAVE ONE THING IN MIND - THE AUTOMOTIVE SERVICE BUSINESS!



WE PUT THE QUALITY IN THE CAN - NOT ON THE CAN!

- ★ Cooling System Cleaner
- ★ Cooling System Conditioner
- ★ Cooling System Stop Leak/Sealer
- ★ Internal Engine Cleaner/Protector
- ★ Engine Tune-up
- ★ Oil Treatment Conditioner
- ★ Automatic Transmission Treatment
- ★ Carburetor & Injection Cleaner
- ★ Fuel Injection Treatment
- ★ Carburetor & Injection Cleaner (Press)
- ★ Gas Treatment
- ★ "PLP" Penetrant-Lubricant-Protectant

"Competition Tested & Proven"

We Support the Sport

— Distributorships Available Nationwide —

If you have been thinking of starting your own distributing business or adding a high quality line of products to your existing business we have a plan for you.

CONTACT:

LYNCH PRO-FORMANCE PRODUCTS

21078 Hwy 99E
Aurora, Oregon 97002
(503) 678-5663

P.O. Box 2227
Atascadero, CA 93423
(805) 466-0450

Heat 1

| Car No. | Driver | Car No. | Driver |
|---------|--------|---------|--------|
| 1. | _____ | _____ | _____ |
| 2. | _____ | _____ | _____ |
| 3. | _____ | _____ | _____ |
| 4. | _____ | _____ | _____ |
| 5. | _____ | _____ | _____ |
| 6. | _____ | _____ | _____ |

Heat 2

| Car No. | Driver | Car No. | Driver |
|---------|--------|---------|--------|
| 1. | _____ | _____ | _____ |
| 2. | _____ | _____ | _____ |
| 3. | _____ | _____ | _____ |
| 4. | _____ | _____ | _____ |
| 5. | _____ | _____ | _____ |
| 6. | _____ | _____ | _____ |

Heat 3

| Car No. | Driver | Car No. | Driver |
|---------|--------|---------|--------|
| 1. | _____ | _____ | _____ |
| 2. | _____ | _____ | _____ |
| 3. | _____ | _____ | _____ |
| 4. | _____ | _____ | _____ |
| 5. | _____ | _____ | _____ |
| 6. | _____ | _____ | _____ |

Heat 4

| Car No. | Driver | Car No. | Driver |
|---------|--------|---------|--------|
| 1. | _____ | _____ | _____ |
| 2. | _____ | _____ | _____ |
| 3. | _____ | _____ | _____ |
| 4. | _____ | _____ | _____ |
| 5. | _____ | _____ | _____ |
| 6. | _____ | _____ | _____ |

Car No. Driver

| | | | |
|----|-------|-------|-------|
| 1. | _____ | _____ | _____ |
| 2. | _____ | _____ | _____ |
| 3. | _____ | _____ | _____ |
| 4. | _____ | _____ | _____ |
| 5. | _____ | _____ | _____ |
| 6. | _____ | _____ | _____ |

Car No. Driver

Car No. Driver

| | | | |
|----|-------|-------|-------|
| 1. | _____ | _____ | _____ |
| 2. | _____ | _____ | _____ |
| 3. | _____ | _____ | _____ |
| 4. | _____ | _____ | _____ |
| 5. | _____ | _____ | _____ |
| 6. | _____ | _____ | _____ |

Car No. Driver

Car No. Driver

| | | | |
|-----|-------|-------|-------|
| 1. | _____ | _____ | _____ |
| 2. | _____ | _____ | _____ |
| 3. | _____ | _____ | _____ |
| 4. | _____ | _____ | _____ |
| 5. | _____ | _____ | _____ |
| 6. | _____ | _____ | _____ |
| 7. | _____ | _____ | _____ |
| 8. | _____ | _____ | _____ |
| 9. | _____ | _____ | _____ |
| 10. | _____ | _____ | _____ |

Car No. Driver

"A" FEATURE

Car No. Driver

| | | | |
|-----|-------|-------|-------|
| 1. | _____ | _____ | _____ |
| 2. | _____ | _____ | _____ |
| 3. | _____ | _____ | _____ |
| 4. | _____ | _____ | _____ |
| 5. | _____ | _____ | _____ |
| 6. | _____ | _____ | _____ |
| 7. | _____ | _____ | _____ |
| 8. | _____ | _____ | _____ |
| 9. | _____ | _____ | _____ |
| 10. | _____ | _____ | _____ |
| 11. | _____ | _____ | _____ |
| 12. | _____ | _____ | _____ |

Car No. Driver

BOB MILLER
PRESIDENT

NED FERLA

Los Gatos Body Shop, Inc.

EXPERT AUTO PAINTING

17462 SHELBURNE WAY LOS GATOS, CALIF.

395-6750

E. HAROLD MILLER FOUNDER · 1955

31 YEARS OF SERVICE

Davis Motors (489 South Market St., San Jose, CA., 408-292-8503) offers these 5 gram charms for racing fans. Avail-



Robin Harford

able in either 14K gold (\$149) or Sterling Silver (\$19.95), they can be ordered by phone using Mastercharge or Visa. Davis will also ship UPS COD.

Tim Green-All-Weld Machine and Fabrication



**AND
WHEELS**

**PARTS AND METHANOL
CIRCLE TRACK RACING EQUIPMENT**

(408) 248-5181

**1700 EL CAMINO REAL
SANTA CLARA, CA. 95051**

STREET TIRES:

B.F. GOODRICH
DUNLAP
DOUGLAS
KELLY
TRISUN
PIRELLI
YOKOHAMA

WHEELS:

WESTERN WHEEL
GOTTI
RONAL
WELDS
CENTERLINE
PANASPORT
MOTORSPORTS WHEEL
B.B.S.
AMERICAN RACING
(408) 227-6262

**Rodriguez
Racing
Equipment**



2970 Daylight Way, San Jose, CA 95111
9 am to 6 pm Monday thru Friday

**QUALITY RACING
EQUIPMENT:**

FUEL CELLS
TIRE GAUGES
DUROMETERS
PYROMETERS
TIRE SOFTENER
SIMPSON SAFETY
SUPER JUGS
FLAMEOUT SYSTEMS
LESLIE (SEATS)
REDLINE OIL
CARRERA SHOCKS

RACING TIRES:

FIRESTONE
MCCREARY

**Fuel delivery
at the track**

Why Not Add A Luxurious Sunroof To Your High Performance Car?

San Francisco Sunroof has the largest selection of high performance sunroofs, with the highest quality installation and lowest prices in Northern California.

Our highly skilled craftsmen can fit a sunroof into almost any car . . . Perfectly . . . WHILE YOU WAIT.

Pop-tops starts as low as \$198.00 INSTALLED. Top of the line electric moonroofs and t-tops are available for only \$59.00 down and \$56.00 a month (OAC) INSTALLED.

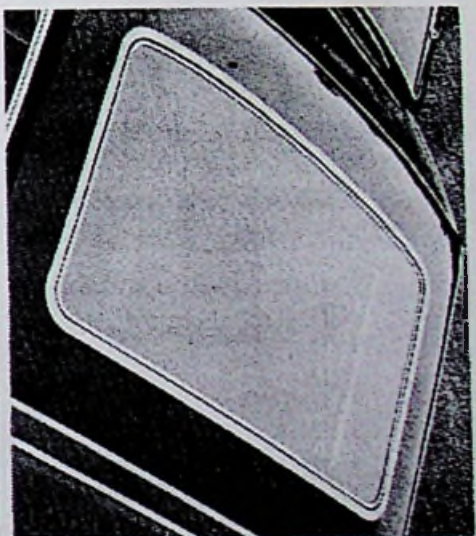

asc[®]
Modular
Electric Sunroof

**Pop-Tops - As Low As
\$198.00 Installed**

Be smart. Add to your lifestyle with a sunroof from San Francisco Sunroof. Take a step up . . . and out into the sun.

Three convenient locations. Visit or give us a call . . .

Financing Available
Visa - Mastercard

See Us At
The World of
Motorsports
Show!

DALY CITY
7298 Mission St.
415-991-7100

HAYWARD
25733 Dollar St.
415-581-5100

SANTA CLARA
1940 Lafayette St.
408-980-1111

SAN FRANCISCO
SUNROOF

The Auto Sunroof Specialists



This is the famous Budweiser beer We know of no brand produced by any other brewer which costs so much to brew and age. Our exclusive Beechwood Aging produces a taste, a smoothness and a drinkability you will find in no other beer at any price



GENUINE

Budweiser[®]

KING OF BEERS.

GENUINE

000848

**MARKSTEIN
BEVERAGES**

2900 VOLPEY WAY • UNION CITY, CA 94587

ANHEUSER-BUSCH, INC. • ST. LOUIS